

Features

- Very compact design
- Flammability corresponding to UL94V-0
- Custom designs are available

Applications

- Power electronics
- Power line in and output filter
- Suppression of common mode noise

General Specifications

- Storage temp range: -40°C to +125°C
- Operating temp range: -40°C to +125°C
- Moisture Sensitivity Level(MSL): 1



► Dimensions & Configurations (Unit:mm)

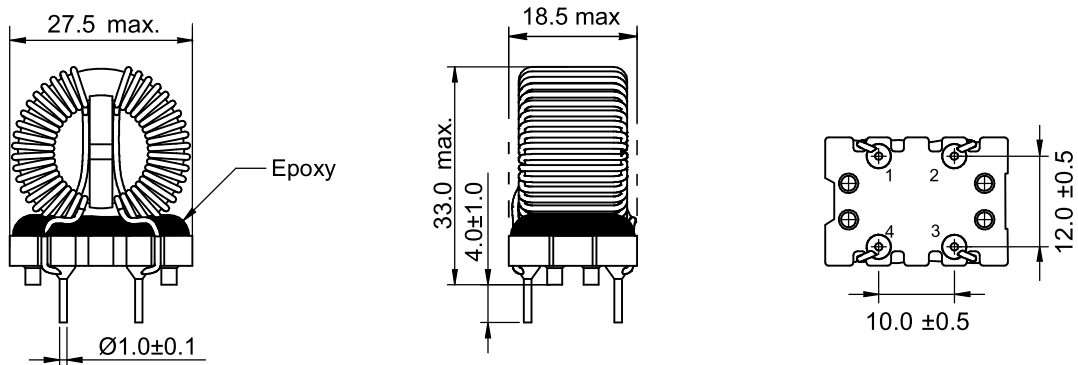

► Recommended Hole Pattern:[mm] ► Schematic

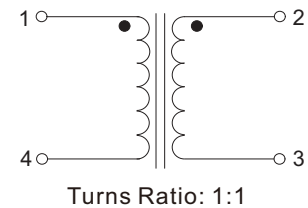
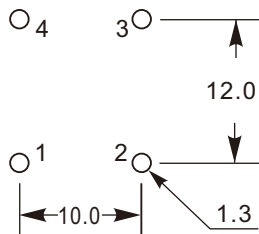

► Electrical Specifications @ 25°C

Part Number	Inductance [mH]	Rated Current [A]	DCR(max) [mΩ]
CTR2214-102N	1.0±30%	7.5	10
CTR2214-222N	2.2±30%	6.0	20
CTR2214-332N	3.3±30%	4.0	35
CTR2214-502N	5.0±30%	4.0	50
CTR2214-702N	7.0±30%	3.5	80
CTR2214-103N	10.0±30%	3.0	105
CTR2214-203N	20.0±30%	2.0	220

- Inductance is per winding tested at 10kHz,0.1V
- Hi-pot:AC1500V/1mA/2S (N1-N2)
- Rated Voltage: 250VAC max